

Pick & Place

All in One

Wrap-around

Palletizers

automatic
PACKAGING
solutions

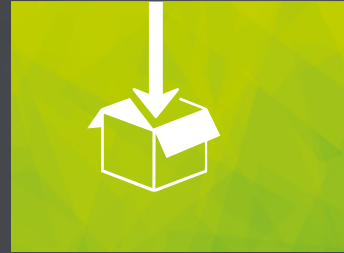

Duetti
packaging



THE COMPANY

DUETTI PACKAGING, WITH OVER FORTY YEARS OF HISTORY, IS A SOLID COMPANY THAT DESIGNS AND MANUFACTURES COMPLETE END-OF-LINE SYSTEMS FOR PACKAGING.

THE HIGH LEVEL OF KNOWLEDGE IN THE SECTOR, THE CONSTANT RESEARCH IN TECHNOLOGICAL INNOVATION AND ATTENTION TO THE CUSTOMER, MAKE DUETTI PACKAGING A COMPANY THAT IS APPRECIATED AND RENOWNED WORLDWIDE.

AWARE AND FORTIFIED BY THE CHALLENGES SUCCESSFULLY FACED IN THE PAST, DUETTI PACKAGING LOOKS TO THE FUTURE WITH CONFIDENCE AND POSITIVITY, OFFERING THE MOST SUITABLE SOLUTION FOR EVERY PRODUCTION NEED.



www.duettipackaging.com





OUR STRENGTHS

EXPERIENCE

Knowledge creates competence

Decades of experience has enabled us to acquire in-depth knowledge of the various production processes in our reference sectors: beverages, detergents, chemicals and pharmaceuticals.



ATTENTION TO THE CUSTOMER

The complete cycle

Our focus is on the customer's production requirements.

The partnership with the customer starts with the analysis and continues through the design adaptation, production, and handover of the machinery. Your production success is our success.

ASSISTENCE & AFTER SALES

You can work without worries

Duetti Packaging is your ideal partner for after-sales support. With a dedicated team and high-profile resources, we guarantee our customers support in the management of spare parts, software updates, regular maintenance programmes and new technical solutions, either remotely or on site at production sites around the world.





DUETTI PACKAGING SOLUTIONS



DEPALLETIZERS



PICK-UP



SWEEP



CARTON
ERECTOR



CARTON
CLOSER



CARTONING



VERTICAL



ALL IN ONE



PICK & PLACE



FLEXROBOT





WRAP AROUND & DISPLAY BOX



CARTON DIVIDER INSERTER



TURNKEY SOLUTIONS



PALLETIZERS



CARTESIAN AXES ROBOT



LAYER



COLUMN ROBOT



FLEXROBOT





PICK-UP DEPALLETIZERS



GENERAL BROCHURE & COMPANY PROFILE





CLICK!
AND PLAY
VIDEO



The pick-up depalletizer is an automatic machine for depalletizing cans, jars, bottles, particularly suitable for medium production lines. Equipped with inflatable tubes head or other types of gripping systems, self-centring gripper, magnet, suction cups, it is customised according to the application. Compact and versatile machine specially designed for environments with height restrictions.

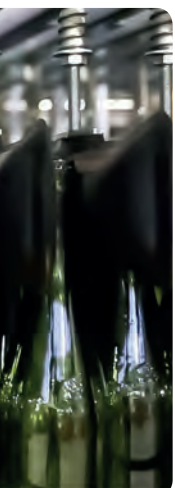

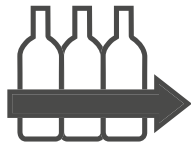

SWEEP DEPALLETIZERS



GENERAL BROCHURE & COMPANY PROFILE





CLICK!
AND PLAY
VIDEO



The Sweep depalletizer is designed to transfer layers of containers of various shapes and types onto an outfeed table. A modular machine that allows both flat plastic layercards and rigid cartons between layers and configured with accessories according to production requirements.





CARTON ERECTOR



GENERAL BROCHURE & COMPANY PROFILE





CLICK!
AND PLAY
VIDEO

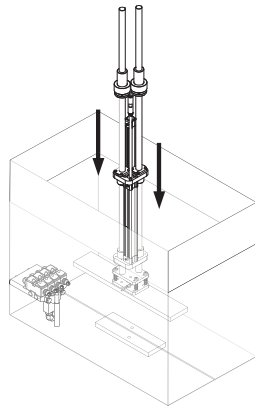

sealing with hot-melt glue

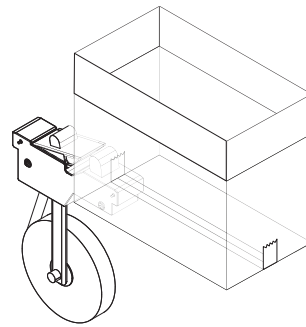

sealing with adhesive tape



Carton erector that opens and seals American-type cartons with adhesive tape or hot melt glue. Compact machine, easy to adjust for format changes.





CARTON CLOSER



GENERAL BROCHURE & COMPANY PROFILE

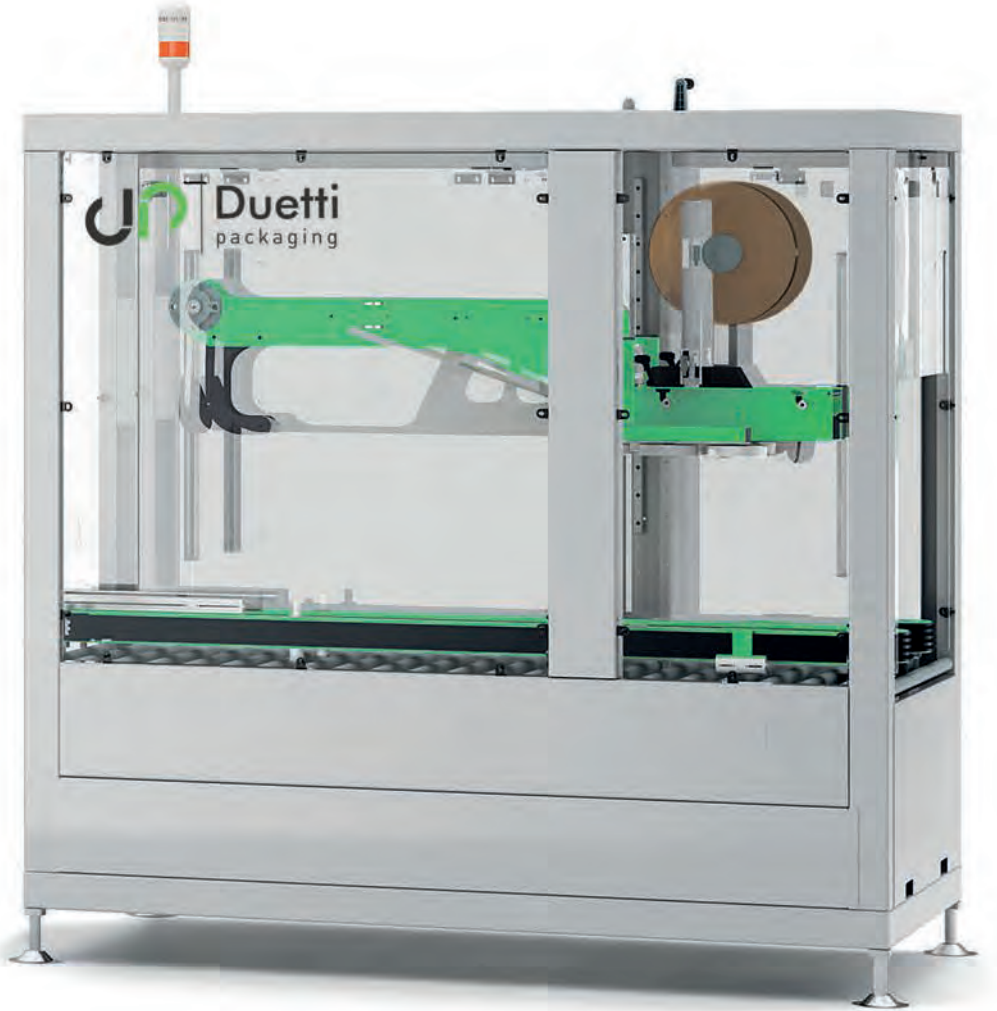



CLICK!
AND PLAY
VIDEO

sealing with hot-melt glue

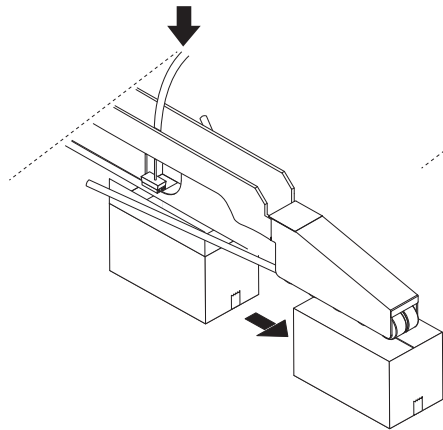

sealing with adhesive tape

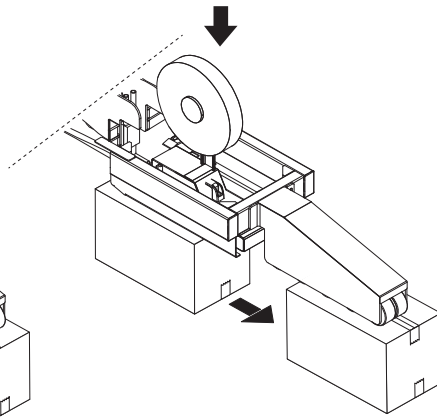

Automatic carton closers that seal the top and bottom flaps of American-style cartons with adhesive tape or hot melt glue.





CARTONING

Automatic cartoning machines
on RSC carton



VERTICAL CARTONING

vertical Cartesian
cartoning



ALL IN ONE

cartoning monoblock
forms, inserts, closes



PICK & PLACE

cartoning by means of
integrated robotics



FLEXROBOT

cartoning by means of
anthropomorphic robots



THE MULTI-SECTOR
EXPERIENCE OF DUETTI
PACKAGING ENSURES
THAT WE CAN WORK
WITH ALL TYPES OF
PRODUCTS



Duetti
packaging





VERTICAL CARTONING



GENERAL BROCHURE & COMPANY PROFILE





CLICK!
AND PLAY
VIDEO



VERTICAL Cartoning machine with Cartesian axis on which the interchangeable product gripping unit is fitted at the end to allow the vertical insertion into one or more cartons and/or trays with different types of products, according to a pre-established configuration.



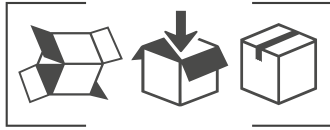

ALL IN ONE CARTONING



GENERAL BROCHURE & COMPANY PROFILE





CLICK!
AND PLAY
VIDEO



ALL IN ONE is a multifunctional cartoning mono-block with carton forming, packing and closure modules which seals with adhesive tape or hot melt glue. Compact and versatile for various needs in the beverage, chemical, food and pharmaceutical industries.



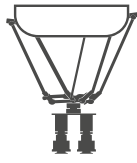

PICK & PLACE CARTONING



GENERAL BROCHURE & COMPANY PROFILE





CLICK!
AND PLAY
VIDEO



PICK & PLACE is a carton packer equipped with integrated robotics and designed to pick up and deposit product in American cartons, plastic crates, or trays. Ideal for high-speed lines in the chemical, beverage, and food industries.





FLEXROBOT CARTONING



GENERAL BROCHURE & COMPANY PROFILE





CLICK!
AND PLAY
VIDEO



FLEXROBOT, a multifunctional anthropomorphic robot designed to be inserted into the various stages of packaging, with the advantage of reducing space and creating solutions that cannot be achieved with traditional systems. Consisting of a long arm on which a gripping head is fitted, depending on the application, it allows for a better operating range in shorter cycle times.



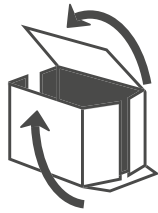

WRAP AROUND & DISPLAY BOX



GENERAL BROCHURE & COMPANY PROFILE

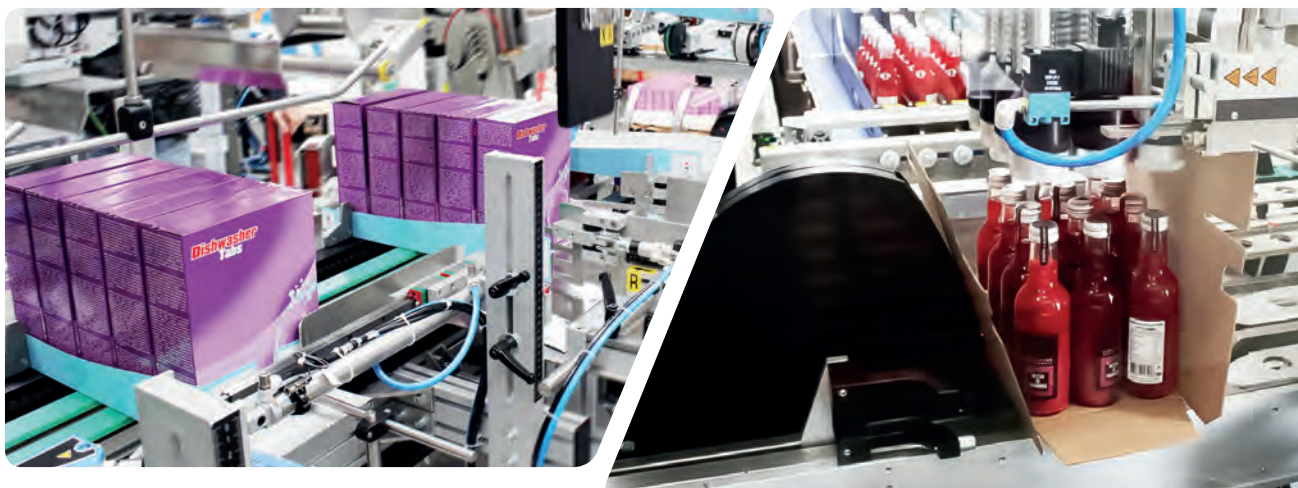



CLICK!
AND PLAY
VIDEO



WRAP-AROUND & DISPLAY BOX machine designed to automatically form, fill, and close cartons by wrapping them around products of various types and shapes. The simple yet functional principle guarantees performance and durability. Easy and quick maintenance, does not require specialised personnel.



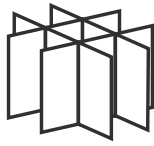

CARTON SEPARATOR INSERTER



GENERAL BROCHURE & COMPANY PROFILE

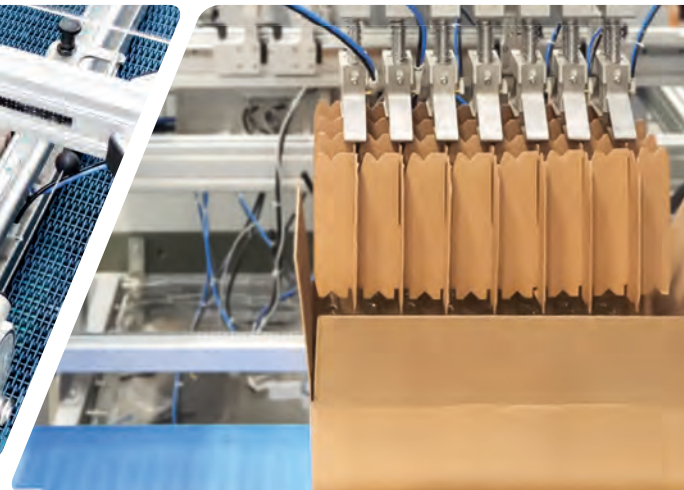
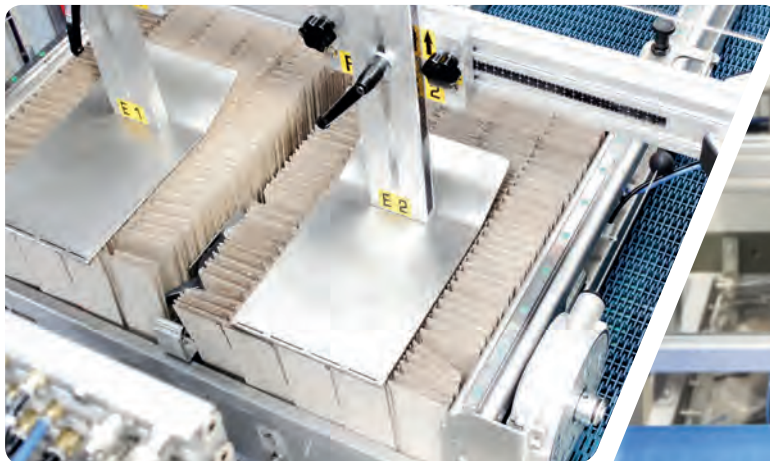



CLICK!
AND PLAY
VIDEO



CARTON separator inserter is an automatic machine designed and conceived for the opening and vertical insertion of the preformed product carton separators in American cartons. A wide range of standard, self-supporting and dimensional carton separators in various configurations. The care taken in the design phase has ensured the creation of an extremely reliable, versatile, and compact machine.





TURNKEY SOLUTIONS



GENERAL BROCHURE & COMPANY PROFILE





CLICK!
AND PLAY
VIDEO



Duetti Packaging, through long-term group synergy, can supply complete turnkey SOLUTIONS, integrating in its range: process lines, depalletizers, cartoners, palletizers, stretch-wrappers, integrated logistics with AGV shuttles and supervision systems.





PALLETIZATION

Semi-automatic or fully automated high-productivity palletizers



CARTESIAN ROBOT

palletization with Cartesian system



LAYER

layer palletization



COLUMN ROBOT

palletization with column robot



FLEXROBOT

palletization with anthropomorphic robot





Duetti
packaging

**WE GUARANTEE THE
MAXIMUM EFFICIENCY OF
OUR SYSTEMS THROUGH
CONTROL AND QUALITY TESTS
CARRIED OUT DURING EACH
WORK PHASE**





CARTESIAN ROBOT



GENERAL BROCHURE & COMPANY PROFILE

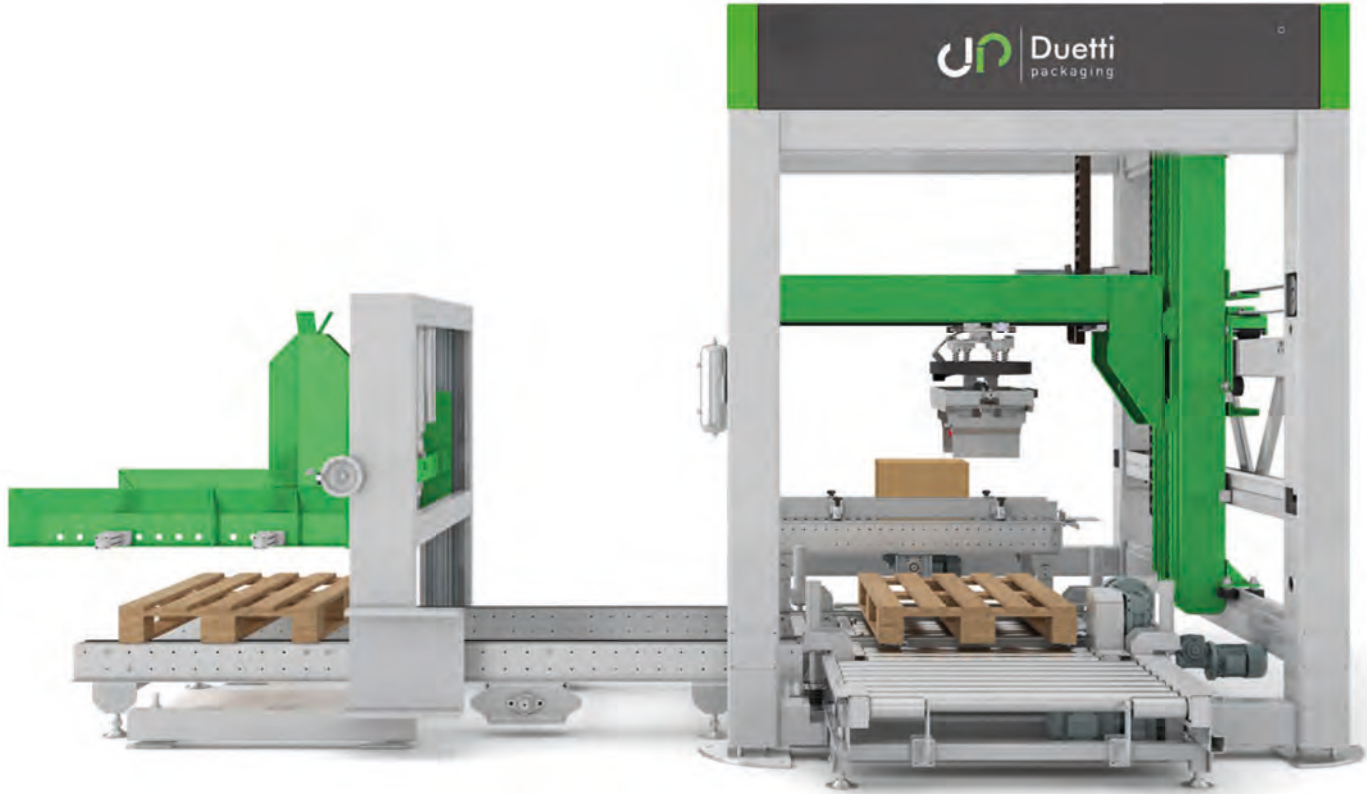



Cartesian Robot with Cartesian axes with a pleasant design that palletizes/depalletizes with a dedicated gripping head depending on the application.

Compact, versatile, modular design that allows the height and length to be configured to the required space.

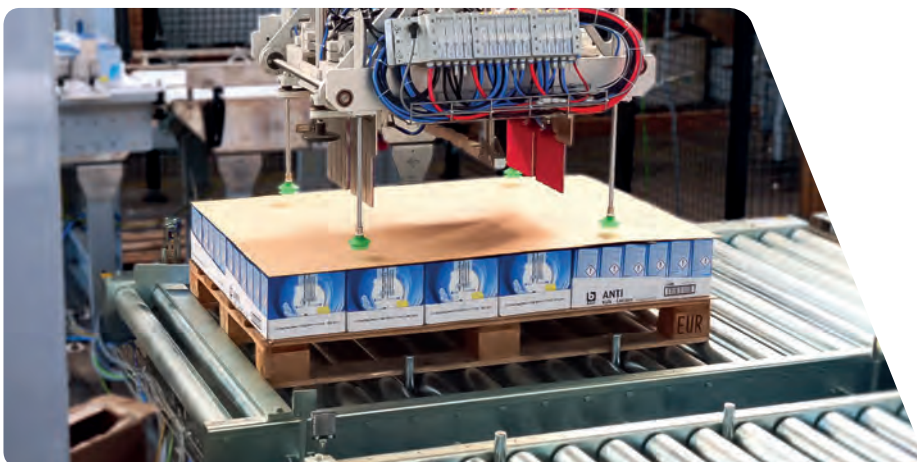



LAYER PALLETIZER



GENERAL BROCHURE & COMPANY PROFILE

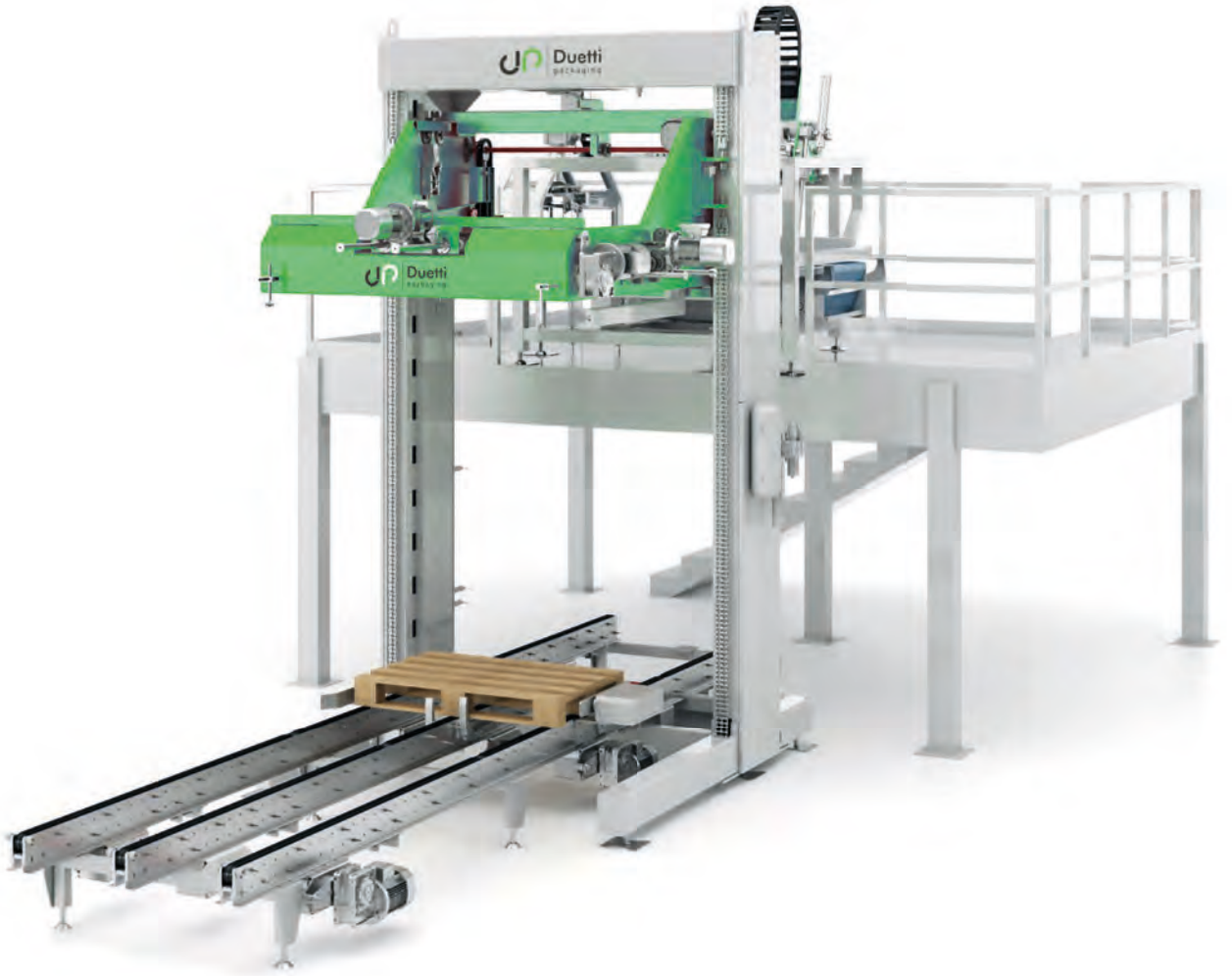



CLICK!
AND PLAY
VIDEO



LAYER PALLETIZER, machine suitable for palletizing cartons, bags, bundles, crates. The product infeed can be at low-level or high-level. It can be fitted with a range of accessories to personalize every application.



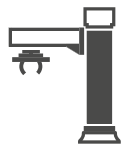

COLUMN ROBOT



GENERAL BROCHURE & COMPANY PROFILE





CLICK!
AND PLAY
VIDEO



COLUMN ROBOT suitable for palletizing boxes, bundles, tanks, crates, bags. Compact and versatile, it has 4 electronically controlled axes and a gripping head that can rotate 360° with the capacity to pick up and deposit product, pallets and layercards. Simple, intuitive operation not to mention a wide range of accessories complete this type of palletizer.





FLEXROBOT

PALLETIZERS



GENERAL BROCHURE & COMPANY PROFILE

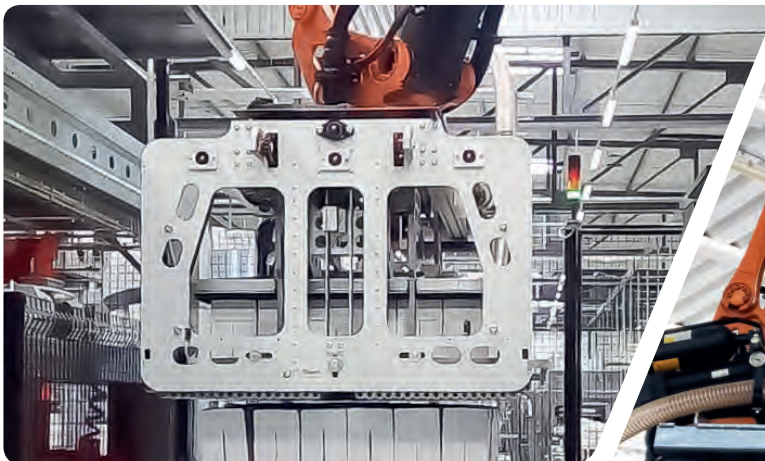

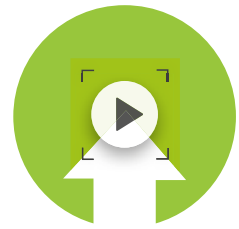

CLICK!
AND PLAY
VIDEO



FLEXROBOT, a multifunctional anthropomorphic robot designed to be inserted into the various stages of packaging, with the advantage of reducing space and creating solutions that cannot be achieved with traditional systems. Consisting of a long arm on which a gripping head is fitted, depending on the application, it allows for a better operating range in shorter cycle times.





www.duettipackaging.com

Duetti Packaging works to Industry 4.0 standards and is ISO 9001:2015 certified.

It designs and builds with environmental awareness, adopting energy-saving measures.

In addition, our products are EAC marked according to the standards required for export to Eurasian Customs Union.





DUETTI PACKAGING S.R.L.

Via Leonardo da Vinci, 43
35015 Galliera Veneta (PD), Italy
Tel. +39 049 9471274
C.F. / P. I. / VAT 04296370283
sales@duettipackaging.com



www.duettipackaging.com



AVG shuttle

Depalletizers

Carton sealers

