

Pick & Place

All in One

Wrap-around

Palletizers

Soluções de  
**EMBALAGEM**  
automatizado



**Duetti**  
packaging



## A EMPRESA

A DUETTI PACKAGING, COM MAIS DE QUARENTA ANOS DE HISTÓRIA, É UMA EMPRESA SÓLIDA QUE PROJETA E FABRICA SISTEMAS COMPLETOS DE FIM DE LINHA PARA EMBALAGENS.

O ALTO NÍVEL DE CONHECIMENTO NO SETOR, A CONSTANTE PESQUISA EM INOVAÇÃO TECNOLÓGICA E ATENÇÃO AO CLIENTE, FAZEM DA DUETTI PACKAGING UMA EMPRESA APRECIADA E RECONHECIDA MUNDIALMENTE.

CONSCIENTE E FORTALECIDA PELOS DESAFIOS ENFRENTADOS COM SUCESSO NO PASSADO, A DUETTI PACKAGING OLHA PARA O FUTURO COM CONFIANÇA E POSITIVIDADE, OFERECENDO A SOLUÇÃO MAIS ADEQUADA PARA CADA NECESSIDADE DE PRODUÇÃO.



[www.duettipackaging.com](http://www.duettipackaging.com)





## NOSSOS PONTOS DE FORÇA

### EXPERIÊNCIA

#### Conhecimento cria competência

As nossas décadas de experiência permitiram-nos desenvolver um profundo conhecimento dos vários processos de produção nos nossos setores de referência: bebidas, detergentes, químico-farmacêuticos.



## ATENÇÃO AO CLIENTE

### O ciclo completo

Nosso foco principal é a atenção às necessidades de produção do cliente. A relação de parceria com o cliente final começa com a análise e segue com a adaptação do projeto, construção e liberação do maquinário. Seu sucesso de fabricação é o nosso sucesso.

## SERVIÇO PÓS-VENDA E ASSISTÊNCIA

### Você pode trabalhar tranquilamente

A Duetti Packaging é o seu parceiro ideal para suporte pós-venda. Com uma equipe dedicada e recursos de alto nível, garantimos aos nossos clientes suporte na gestão de peças de reposição, atualizações de software, programas de manutenção regular e novas soluções técnicas, remotamente ou in loco em locais de produção em todo o mundo.





# SOLUÇÕES

DUETTI PACKAGING



## DESPALETIZADORES



DE RETIRO



DE IMPULSO



FORMA  
CAIXAS



FECHA  
CAIXAS



## EMBALAGEM



VERTICAL



ALL IN ONE



PICK & PLACE



FLEXROBOT





## WRAP AROUND & DISPLAY BOX



## INSERIDOR DE SEPARADOR DE CAIXAS



## SOLUÇÕES CHAVE NA MÃO



## PALETIZADORES



ROBÔ  
CARTESIANO



A CAMADA



ROBÔ  
CIRCULAR



FLEXROBOT





# DESPALETIZADORES DE RETIRO



GENERAL BROCHURE & COMPANY PROFILE





**CLICK!**  
AND PLAY  
VIDEO



O DESPALETIZADOR DE RETIRADA é uma máquina automática para a despaletização de frascos, latas, garrafas, particularmente indicada para linhas médias de produção. Equipado com cabeça de tubo inflável ou outros perfis de prensão, pinça autocentrante, ímã, ventosas e é personalizado de acordo com as aplicações. Máquina compacta e versátil estudada e projetada especificamente para ambientes com restrições de altura.

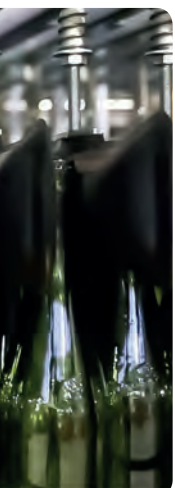

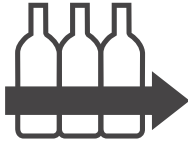

# DESPALETIZADORES DE IMPULSO



GENERAL BROCHURE & COMPANY PROFILE





**CLICK!**  
AND PLAY  
VIDEO



O DESPALETIZADOR DE IMPLUSO foi projetado para a transferência da camada de recipientes de várias formas e tipos no plano de saída. Máquina modular que permite tanto camadas planas em plástico quanto papelão rígidos entre as camadas e configurada com acessórios de acordo com a necessidade de produção.





# FORMA CAIXAS



GENERAL BROCHURE & COMPANY PROFILE





**CLICK!**  
AND PLAY  
VIDEO

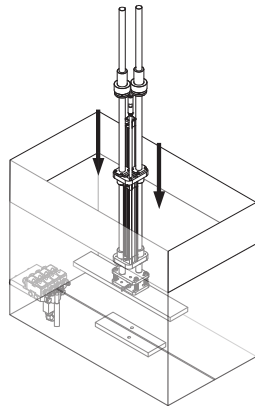

sellado con cola

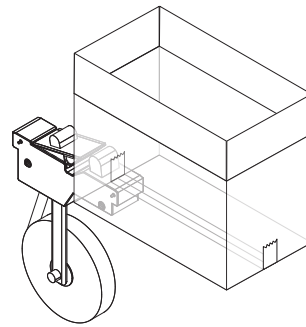

sellado con cinta adhesiva

A FORMA DE CAIXA abre e cola o papelão tipo americano com fita adesiva ou cola hot melt. Máquina compacta, de fácil ajuste para mudança de formato.





# FECHA CAIXAS



GENERAL BROCHURE & COMPANY PROFILE

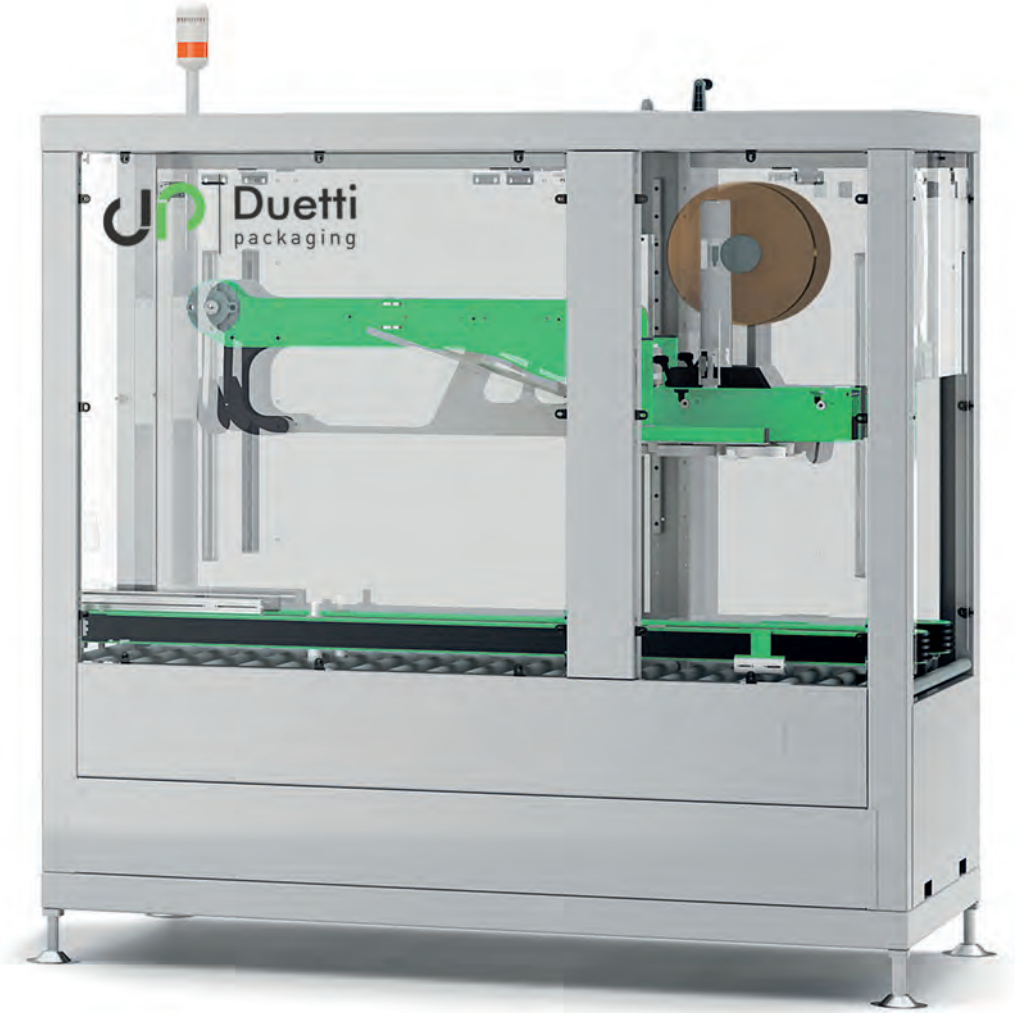



**CLICK!**  
AND PLAY  
VIDEO

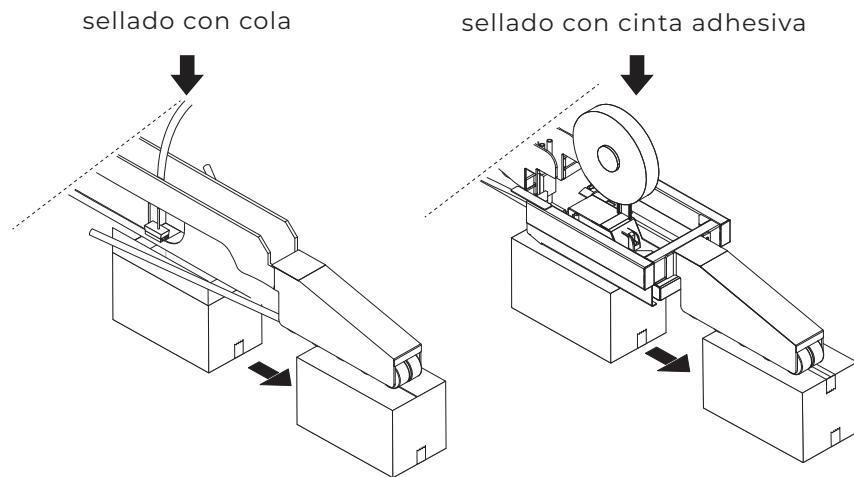

A MÁQUINA AUTOMÁTICA de fechamento de caixas cola as abas superiores e inferiores das caixas do tipo americano com fita adesiva ou cola hot melt.





## EMBALAGEM

Máquinas de embalagens automáticas em caixa RSC



### VERTICAL

Ebalagem cartesiano vertical



### ALL IN ONE

monobloco que forma, insere, fecha

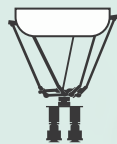

### PICK & PLACE

Embalagem com robótica integrada



### FLEXROBOT

Embalagem com robô antropomórfico



A EXPERIÊNCIA  
MULTISSECTORIAL DA  
DUETTI PACKAGING  
PERMITE TRABALHAR  
EM 360° COM TODOS OS  
TIPOS DE PRODUTOS



**Duetti**  
packaging





# EMBALAGEM VERTICAL



GENERAL BROCHURE & COMPANY PROFILE





**CLICK!**  
AND PLAY  
VIDEO



EMBALADORA com eixo cartesiano no qual é fixada na extremidade o equipamento de prensão de produtos intercambiáveis para permitir a inserção vertical de uma ou mais caixas e/ou bandejas com produtos de diferentes tipos, de acordo com uma configuração pré-estabelecida.



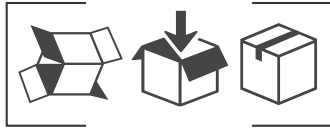

# EMBALAGEM ALL IN ONE



GENERAL BROCHURE & COMPANY PROFILE





**CLICK!**  
AND PLAY  
VIDEO



ALL-IN-ONE é um monobloco de embalagem multifuncional feito com módulo de formação, estação de embalagem e fechamento com fita adesiva ou cola hot melt. Compacto e versátil para diversos tipos de exigências para cartonagem nos setores de bebidas, químico, alimentício e farmacêutico.



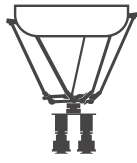

# EMBALAGEM PICK & PLACE



GENERAL BROCHURE & COMPANY PROFILE





**CLICK!**  
AND PLAY  
VIDEO



PICK & PLACE é uma embaladora equipada com robótica integrada e projetada para coletar e depositar produtos em caixas americanas, engradados plásticos ou bandejas. Ideal para linhas de alta velocidade nas indústrias química, de bebidas e alimentícia.





# EMBALAGEM FLEXROBOT



GENERAL BROCHURE & COMPANY PROFILE

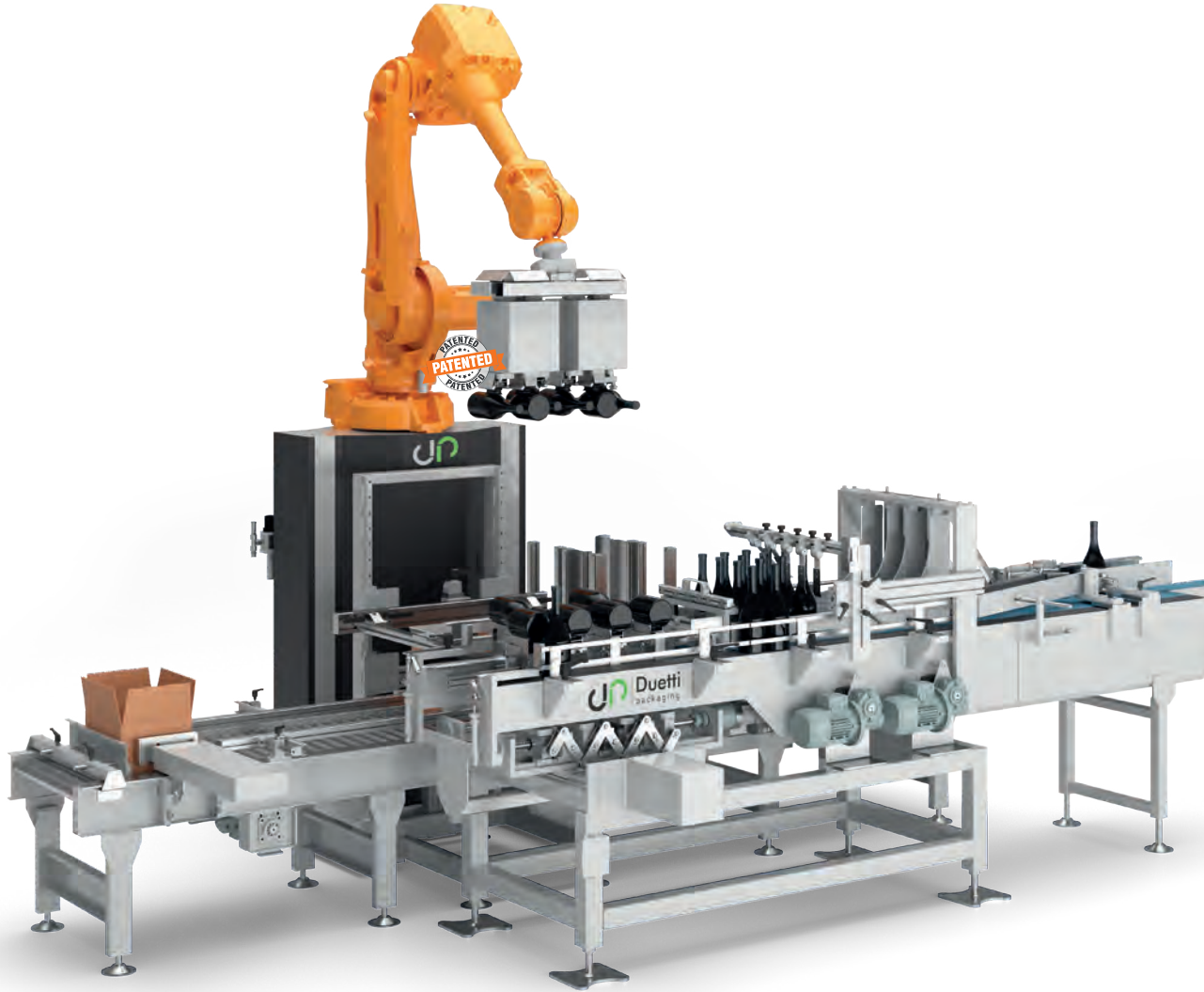



**CLICK!**  
AND PLAY  
VIDEO



O FLEXROBOT é um robô antropomórfico multifuncional projetado e refalizado para ser inserido nas diversas etapas de embalagem, com a vantagem de reduzir espaço e criar soluções que não são alcançadas com sistemas tradicionais. Composto por um braço longo no qual está integrada a adequada cabeça de preensão, dependendo da aplicação, permite trabalhar em uma melhor faixa de operação e em tempos de ciclo mais curtos.





# WRAP AROUND & DISPLAY BOX



GENERAL BROCHURE & COMPANY PROFILE

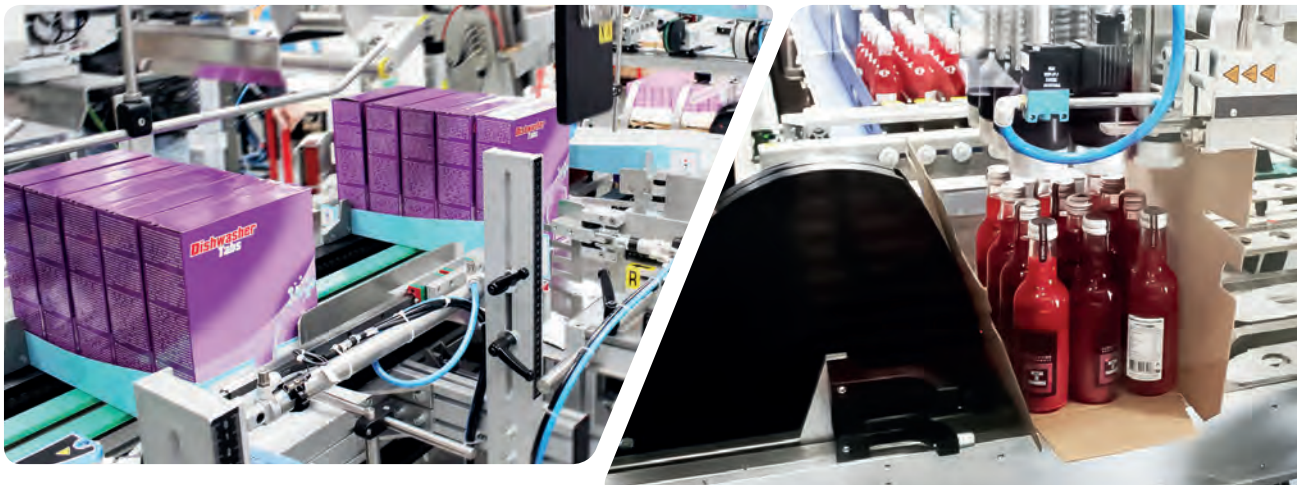
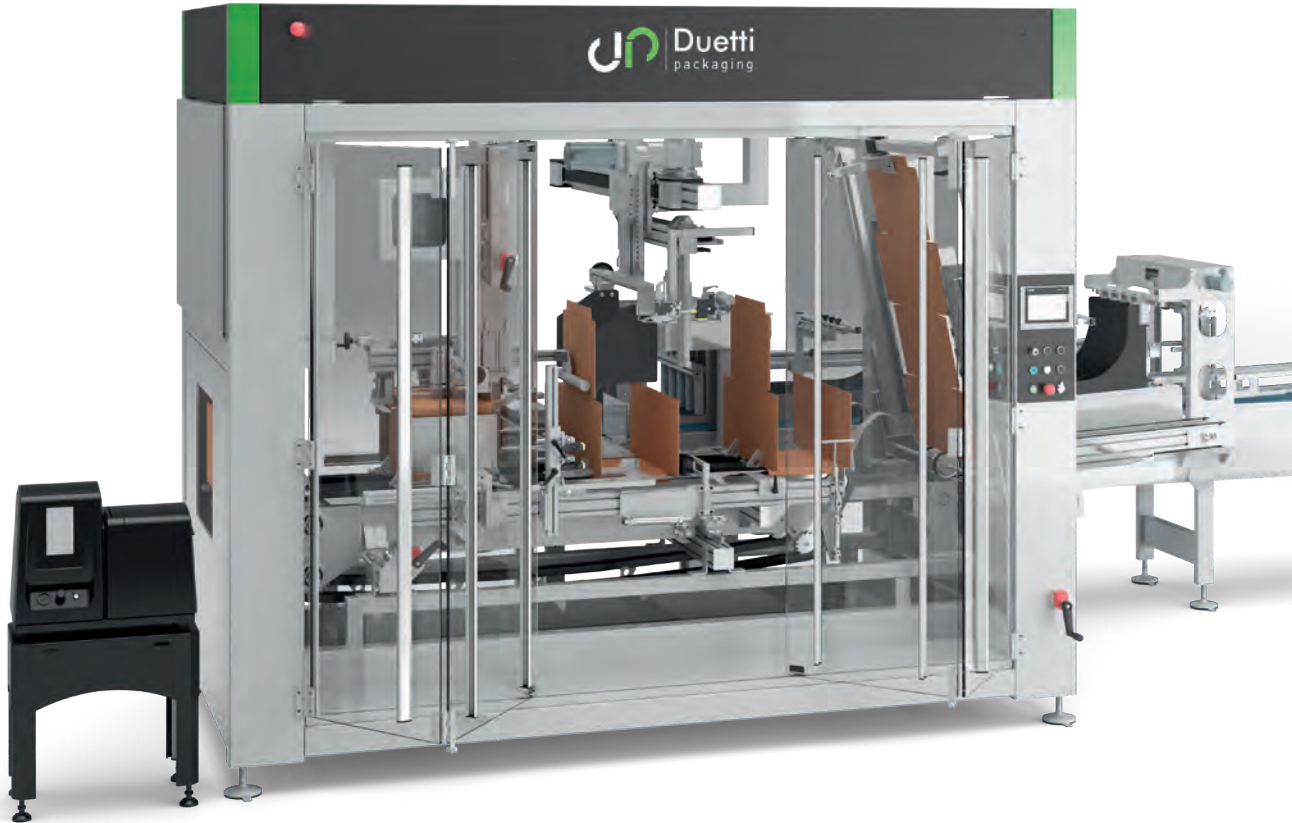



**CLICK!**  
AND PLAY  
VIDEO



WRAP-AROUND & DISPLAY BOX é uma máquina projetada para formar, encher e fechar caixas automaticamente, envolvendo-as em torno do produto de vários tipos e formas. O princípio simples, mas ao mesmo tempo funcional, garante desempenho e durabilidade. A manutenção rápida e fácil não requer pessoal especializado.



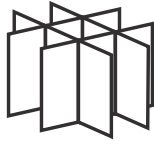

# INSERIDOR DE SEPARADOR DE CAIXAS



GENERAL BROCHURE & COMPANY PROFILE





**CLICK!**  
AND PLAY  
VIDEO



O INSERIDOR DE SEPARADOR DE CAIXAS é uma máquina automática projetada e concebida para a abertura vertical e inserção da colmeia pré-formada para a separação de produtos em caixas americanas. Uma ampla gama de colmeias padrão, autoportantes e dimensionais em várias configurações. A precisão no projeto permitiu obter uma máquina extremamente confiável, versátil e compacta de tamanho.





# SOLUÇÕES CHAVE NA MÃO



GENERAL BROCHURE & COMPANY PROFILE





**CLICK!**  
AND PLAY  
VIDEO



Graças às sinergias do grupo consolidadas ao longo do tempo, a Duetti Packaging pode criar sistemas e instalações completas, integrando em sua gama: linhas de processo, despaletizadoras, embalagem, paletizadoras, bobinadeiras, logística integrada com carros AGV e sistemas de supervisão.





# PALETIZAÇÃO

Paletizadores semiautomáticos ou totalmente automatizados e de alta produtividade



## ROBÔ CARTESIANO

sistema de paletização cartesiano



## A CAMADA

paletização em camadas



## ROBOT CIRCULAR

paletização com robô circular



## FLEXROBOT

paletização com robô antropomórfico





**Duetti**  
packaging

**GARANTIMOS A MÁXIMA  
EFICIÊNCIA DOS NOSSOS  
SISTEMAS ATRAVÉS DE  
CONTROLE E TESTES DE  
QUALIDADE REALIZADOS EM  
CADA FASE DE TRABALHO**





# ROBÔ CARTESIANO



GENERAL BROCHURE & COMPANY PROFILE





**CLICK!**  
AND PLAY  
VIDEO



ROBÔ CARTESIANO com eixos cartesianos com um projeto agradável que paletiza / despaletiza com uma cabeça de prensão especial dedicada à aplicação. Estrutura compacta, versátil e modular que permite configurar a altura e o comprimento nos espaços necessários.

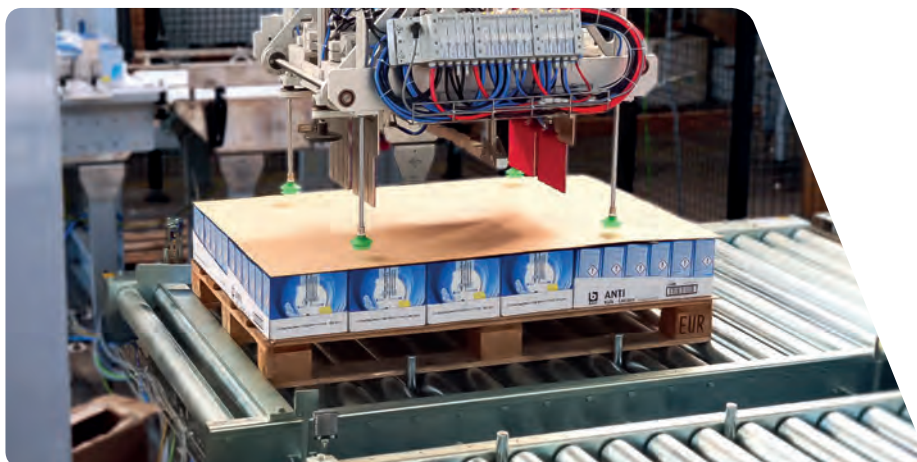



# PALETIZADOR A CAMADA



GENERAL BROCHURE & COMPANY PROFILE

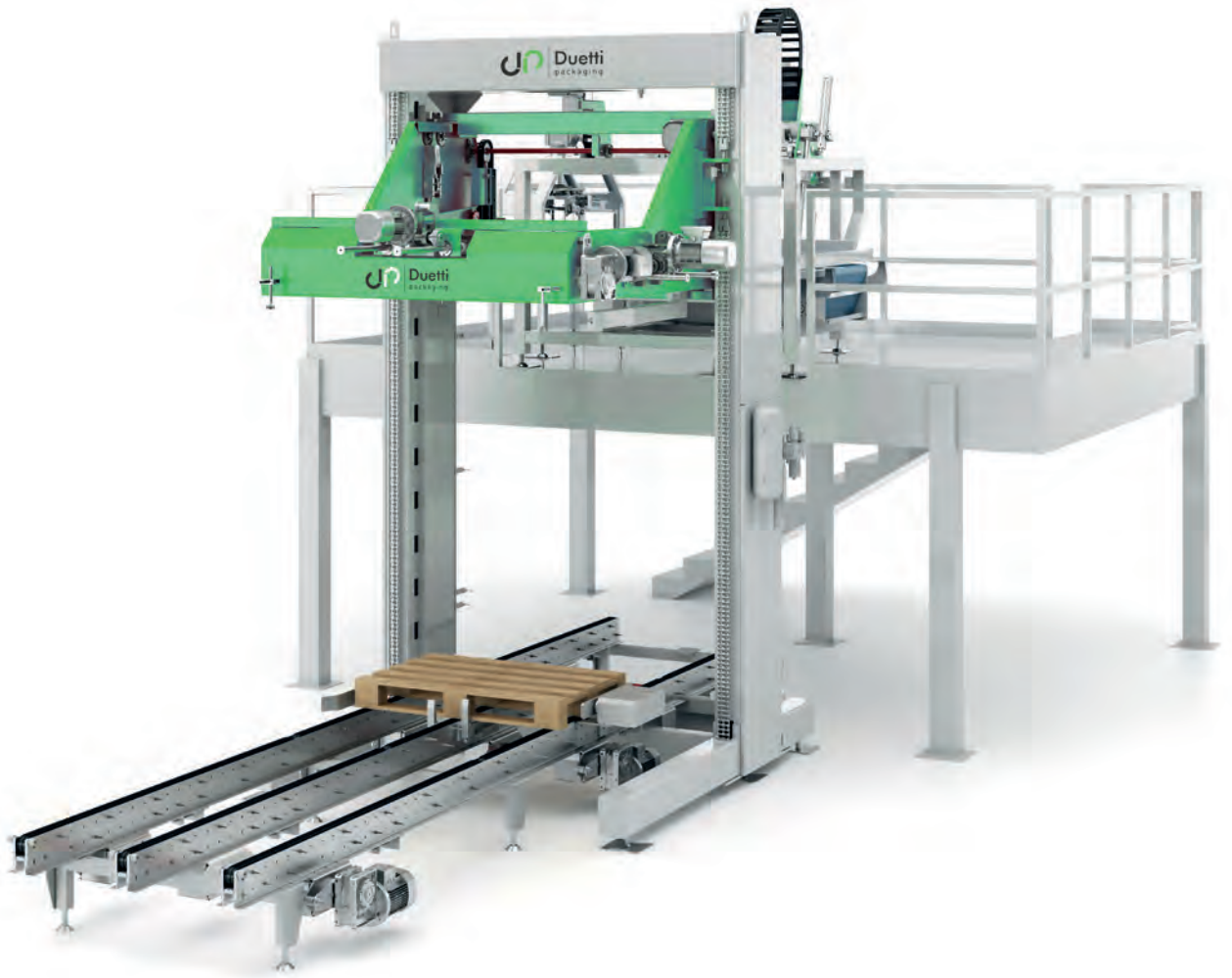



**CLICK!**  
AND PLAY  
VIDEO



PALETIZADOR DE CAMADAS, máquina adequada para paletização de caixas, sacos, pacotes, engradados. A alimentação do produto pode ser em nível baixo ou alto. Equipado com uma gama de acessórios para personalizar cada aplicação.





# ROBÔ CIRCULAR



GENERAL BROCHURE & COMPANY PROFILE





**CLICK!**  
AND PLAY  
VIDEO



ROBÔ CIRCULAR adequado para paletização de caixas, pacotes, latas, engradados, sacos. Compacto e versátil, possui 4 eixos controlados eletronicamente e uma cabeça de prensão que pode girar 360° com capacidade para pegar e depositar produto, zonz paletes e cartões de camada. Operação simples e intuitiva, que acompanha uma ampla gama de acessórios que completam este tipo de paletizadora.





# FLEXROBOT

## PALETIZADOR



GENERAL BROCHURE & COMPANY PROFILE

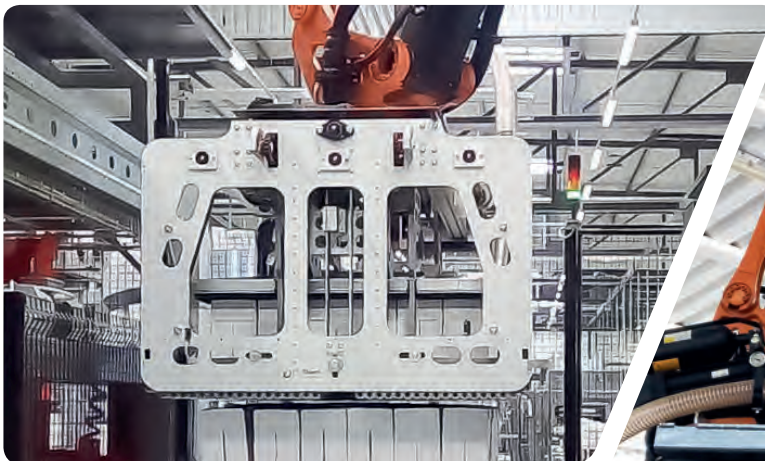



**CLICK!**  
AND PLAY  
VIDEO



O FLEXROBOT é um robô antropomórfico multifuncional projetado e refalizado para ser inserido nas diversas etapas de embalagem, com a vantagem de reduzir espaço e criar soluções que não são alcançadas com sistemas tradicionais. Composto por um braço longo no qual está integrada a adequada cabeça de prensão, dependendo da aplicação, permite trabalhar em uma melhor faixa de operação e em tempos de ciclo mais curtos.





[www.duettipackaging.com](http://www.duettipackaging.com)

A Duetti Packaging opera com as Normas da Indústria 4.0 e possui certificação ISO 9001:2015.

Ela projeta e constrói com atenção ao meio ambiente, adotando medidas para economia de energia.

Além disso, nossos produtos são marcados EAC de acordo com os padrões exigidos para exportação para a União Aduaneira Euroasiática.





**DUETTI PACKAGING S.R.L.**

Via Leonardo da Vinci, 43  
35015 Galliera Veneta (PD), Italy  
Tel. +39 049 9471274  
C.F. / P. I. / VAT 04296370283  
sales@duettipackaging.com



[www.duettipackaging.com](http://www.duettipackaging.com)

